

Features

- Push switch option
- Compact, rugged design
- High reliability
- Metal bushing/shaft



PEC09 Series - 9 mm Incremental Encoder

Electrical Characteristics

Output.....	2-bit quadrature code
Closed Circuit Resistance.....	3 ohms maximum
Contact Rating.....	10 mA @ 5 VDC
Insulation Resistance.....	100 megohms @ 250 VDC
Dielectric Withstanding Voltage	
Sea Level.....	300 VAC minimum
Electrical Travel.....	Continuous
Contact Bounce (15 RPM).....	5.0 ms maximum**
RPM (Operating).....	60 maximum**

Environmental Characteristics

Operating Temperature Range.....	-10 °C to +70 °C (+14 °F to +158 °F)
Storage Temperature Range.....	-40 °C to +85 °C (-40 °F to +185 °F)
Humidity.....	MIL-STD-202, Method 103B, Condition B
Rotational Life.....	30,000 cycles minimum
IP Rating.....	IP 40

Mechanical Characteristics

Mechanical Angle.....	360 ° continuous
Torque	
Running/Detent.....	30 to 200 gf.cm (0.42 to 2.7 oz.-in.)
Mounting.....	10.0 kgf.cm (8.67 lb.-in.) maximum
Terminal Bend Strength.....	300 gf (10.6 ozf)
Shaft Push-Pull Strength.....	10 kgf (22 lbf)
Weight.....	5 gm (0.17 oz.) maximum
Terminals.....	Printed circuit board terminals
Soldering Condition	
Wave Soldering.....	Sn95.5/Ag2.8/Cu0.7 solder with no-clean flux: 260 °C max. for 3-5 seconds
Hand Soldering.....	Not recommended
Hardware.....	One flat washer and one mounting nut supplied with each encoder

Switch Characteristics

Switch Type.....	Contact Push ON Momentary SPST
Switch Life.....	20,000 cycles minimum
Power Rating (Resistive Load).....	10 mA at 5 V DC
Switch Travel.....	See How to Order
Switch Actuation Force.....	300 ± 200 gf (10.6 ± 7.0 ozf)

How To Order

PEC09 - 2 0 20 F - S 0012

Model.....	PEC09 - 2 0 20 F - S 0012
Terminal Configuration.....	2 = PC Pin Vertical/Side Exit
Detent Option.....	0 = No Detents (12, 15 pulses) 1 = 12 Detents (12 pulses) 2 = 24 Detents (12 pulses) 3 = 30 Detents (15 pulses)
Standard Shaft Length.....	15 = 15.0 mm 20 = 20.0 mm 25 = 25.0 mm
Shaft Style.....	F = Metal Flatted Shaft K = Metal Knurled Shaft
Switch Configuration.....	N = No Switch S = Push Momentary (0.5 mm stroke) T = Push Momentary (1.5 mm stroke)
Resolution.....	0012 = 12 Pulses per 360 ° Rotation 0015 = 15 Pulses per 360 ° Rotation

Quadrature Output Table

CW →

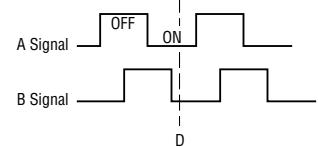

Suggested Filter Circuit

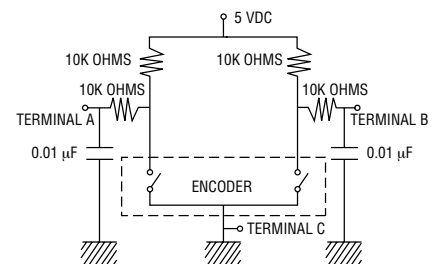

Switch Circuit

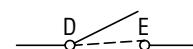

CIRCUIT DIAGRAM

*RoHS Directive 2002/95/EC Jan. 27, 2003 including annex and RoHS Recast 2011/65/EU June 8, 2011.

**Devices are tested using standard noise reduction filters.

For optimum performance, designers should use noise reduction filters in their circuits.

Specifications are subject to change without notice.

The device characteristics and parameters in this data sheet can and do vary in different applications and actual device performance may vary over time.

Users should verify actual device performance in their specific applications.

Applications

Level control, tuning and timer settings in:

- Audio-visual equipment
- Consumer electric appliances
- Environmental controls
- Musical instrumentation
- Communications equipment

PEC09 Series - 9 mm Incremental Encoder



Product Dimensions

PEC09-2xxxF-Nxxxx

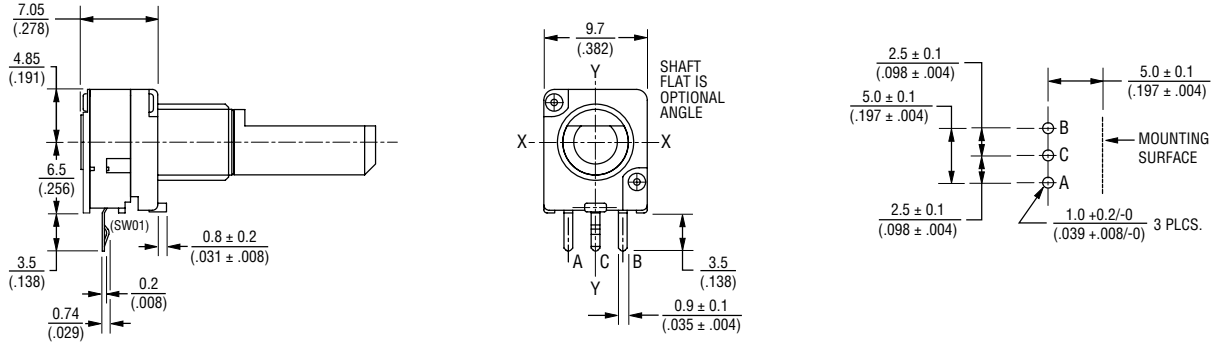

PEC09-2xxxF-Sxxxx

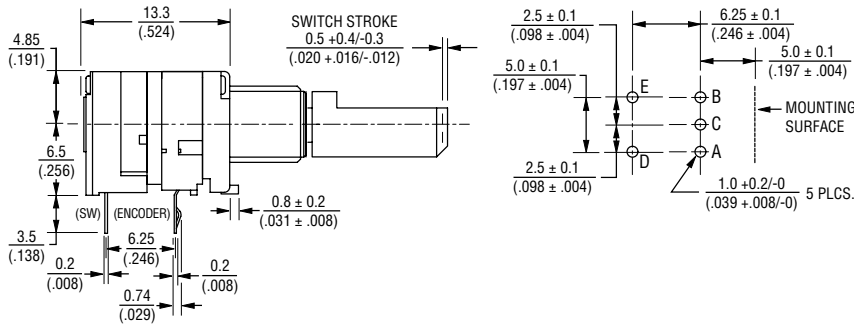

PEC09-2xxxF-Txxxx

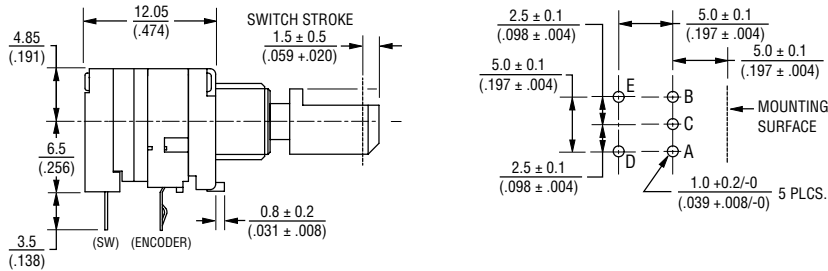

DIMENSIONS: $\frac{\text{MM}}{\text{(INCHES)}}$

Locating Lug Detail

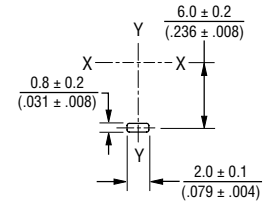

Hardware

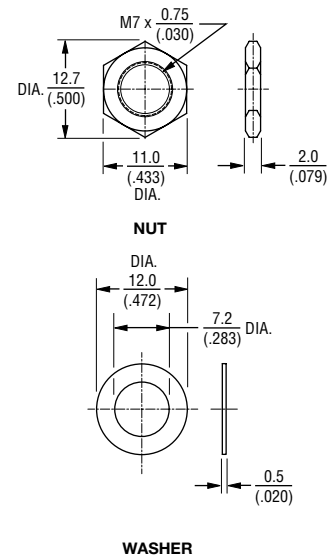

Specifications are subject to change without notice. The device characteristics and parameters in this data sheet can and do vary in different applications and actual device performance may vary over time. Users should verify actual device performance in their specific applications.

PEC09 Series - 9 mm Incremental Encoder

BOURNS®

Shaft Options

PEC09-2xxxx-Nxxxx

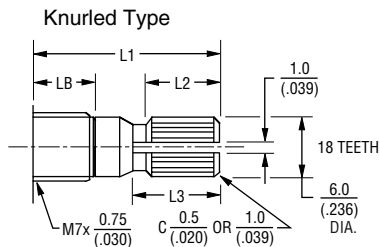

L1	LB	L2	L3
15 (.591)	5.0 (.197)	6.0 (.236)	7.0 (.276)
20 (.787)	7.0 (.276)	10.0 (.394)	11.0 (.433)
25 (.984)	10.0 (.394)	10.0 (.394)	11.0 (.433)

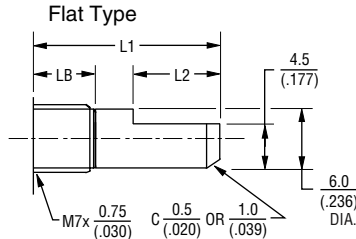

L1	LB	L2
15 (.591)	5.0 (.197)	7.0 (.276)
20 (.787)	7.0 (.276)	12.0 (.472)
25 (.984)	10.0 (.394)	12.0 (.472)

PEC09-2xxxx-Sxxxx (0.5 mm Switch Stroke)

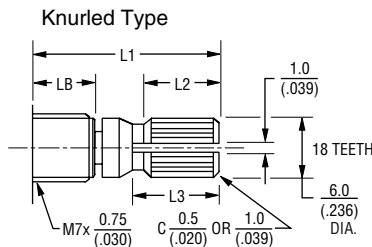

L1	LB	L2	L3
15 (.591)	5.0 (.197)	6.0 (.236)	7.0 (.276)
20 (.787)	7.0 (.276)	9.0 (.354)	10.0 (.394)
25 (.984)	10.0 (.394)	9.0 (.354)	10.0 (.394)

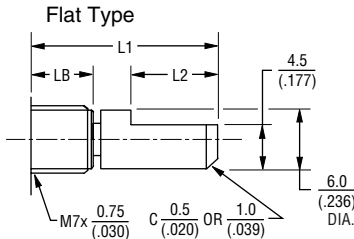

L1	LB	L2
15 (.591)	5.0 (.197)	7.0 (.276)
20 (.787)	7.0 (.276)	10.0 (.394)
25 (.984)	10.0 (.394)	10.0 (.394)

PEC09-2xxxx-Txxxx (1.5 mm Switch Stroke)

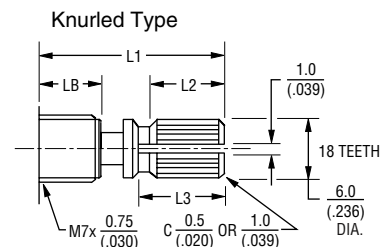

L1	LB	L2	L3
15 (.591)	5.0 (.197)	5.0 (.197)	6.0 (.236)
20 (.787)	7.0 (.276)	8.0 (.315)	9.0 (.354)
25 (.984)	10.0 (.394)	8.0 (.315)	9.0 (.354)

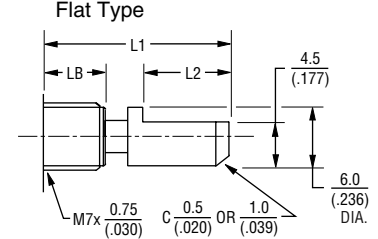

L1	LB	L2
15 (.591)	5.0 (.197)	7.0 (.276)
20 (.787)	7.0 (.276)	10.0 (.394)
25 (.984)	10.0 (.394)	10.0 (.394)

DIMENSIONS: $\frac{\text{MM}}{\text{(INCHES)}}$

BOURNS®

Asia-Pacific: Tel: +886-2 2562-4117 • Email: asiacus@bourns.com

EMEA: Tel: +36 88 520 390 • Email: eurocus@bourns.com

The Americas: Tel: +1-951 781-5500 • Email: americus@bourns.com

www.bourns.com

REV. 10/16

Specifications are subject to change without notice.

The device characteristics and parameters in this data sheet can and do vary in different applications and actual device performance may vary over time. Users should verify actual device performance in their specific applications.